



**NESPA**  
TILED SPAS

# **Production Booklet**

**for**

## **TELFORD PLUNGE**

2800 Richter Ave. Suite C, Oroville, CA 95965 • **voice:** (530)534-9910  
**fax:** (530)534-9915 • **email:** sales@tiledspas.com • **website:** www.tiledspas.com



## RECOMMENDED MAINTENANCE

### *Please Note:*

These are only recommended guidelines to care for a Nespa all tiled spa. Local codes may require additional procedures, therefore consult with a pool professional that is LA county Health Department certified for more information on local codes and requirements.

### **SPA SURFACE**

Your spa tile is acid resistant and frost-proof. The Tile does not absorb germs or algae. Tile does not stain and is very easy to clean. Color does not fade or lose its luster. All grouts are epoxy based and are extremely durable. To remove scum line use soft nylon brush and small amounts of biodegradable soaps. Do not use abrasive brushes or chemicals.

### MAINTENANCE

#### **A. CHEMICALS:**

- 1) It is important to maintain a chlorine residual of 2 PPM in the spa. That residual can be provided by chlorine or bromine.
- 2) It is recommended to use Bromine or dichlor (granular) forms of chlorine. If bromine Tabs are used we suggest floating or inline dispenser.
- 3) Never use acid to lower Ph in the tile spa.
- 4) Never use trichlor chlorine (1" or 3") tablets in the Nespa spas.
- 5) Never place tablets in skimmer basket.

#### **B. DRAINING THE SPA:**

- 1) It is recommended to drain the spa at least once every 2 months depending on bath load and water clarity.
- 2) The spa should be drained through valve exiting re-circulation pump in the spa equipment room or sump pump.
- 3) Note: Use caution to drain spa in the winter months or rainy season when water table is at its highest. It is possible for the spa to float due to hydraulic pressure from surrounding water table. We advise that you consult with your local spa specialist prior to draining the spa.

#### **C. SPA EQUIPMENT:**

- 1) Clean filter cartridge at least once every month, or when needed; i.e., if water clarity does not improve after several days.
- 2) Keep area free and clear from leaves and debris build-up.
- 3) Keep area free and clear from flooding.

#### **D. SPA LIGHT:**

- 1) Spa light has to be on GFCI circuit. It is controlled at spa side with ON/OFF.

#### **E. TILE SERVICING:**

- 1) Contact manufacture when servicing tile or grout. @ (530) 534-9910

SPECIFICATIONS	
MODEL	8' Plunge
SHELL WEIGHT	5000 LBS.
WATER WEIGHT	23517 LBS.
TOTAL SHELL & WATER WEIGHT	28517 LBS.
WATER VOLUME	377 Cu.Ft.
WATER GALLONS	2820 GAL.
SURFACE AREA	50.3 SQ. FT.
ICC ES LISTED #	PMG-1161

**SKID SUPPORT STRUCTURE\* BONDED TO SPA**

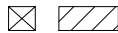
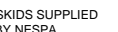

\*SKIDS SUPPLIED BY NESPA

**LIGHT NICHE**

 *Nexus LED Light*

**SIDEWALL SUCTION**

 5" HIGH FLOW SUCTIONS  
 Waterway 640-357xV  
 Super Hi-Flo Suction Assy.  
 Max Flow 180 GPM  
 Complies w/ ANSI Code ASME A112.19.8-2008 & VGB 2008

**RETURN**



INLET FITTINGS  
 1-1/2" WALL TYPE W/ EYEBALL  
 HYDROAIR #10-3500  
 COMPLIES W/ ANSI CODE ASME A112.19.8-08  
 UL APPROVED

**FILL**



INLET FITTINGS  
 1-1/2" WALL TYPE W/ EYEBALL  
 HYDROAIR #10-3500  
 COMPLIES W/ ANSI CODE ASME A112.19.8-08  
 UL APPROVED

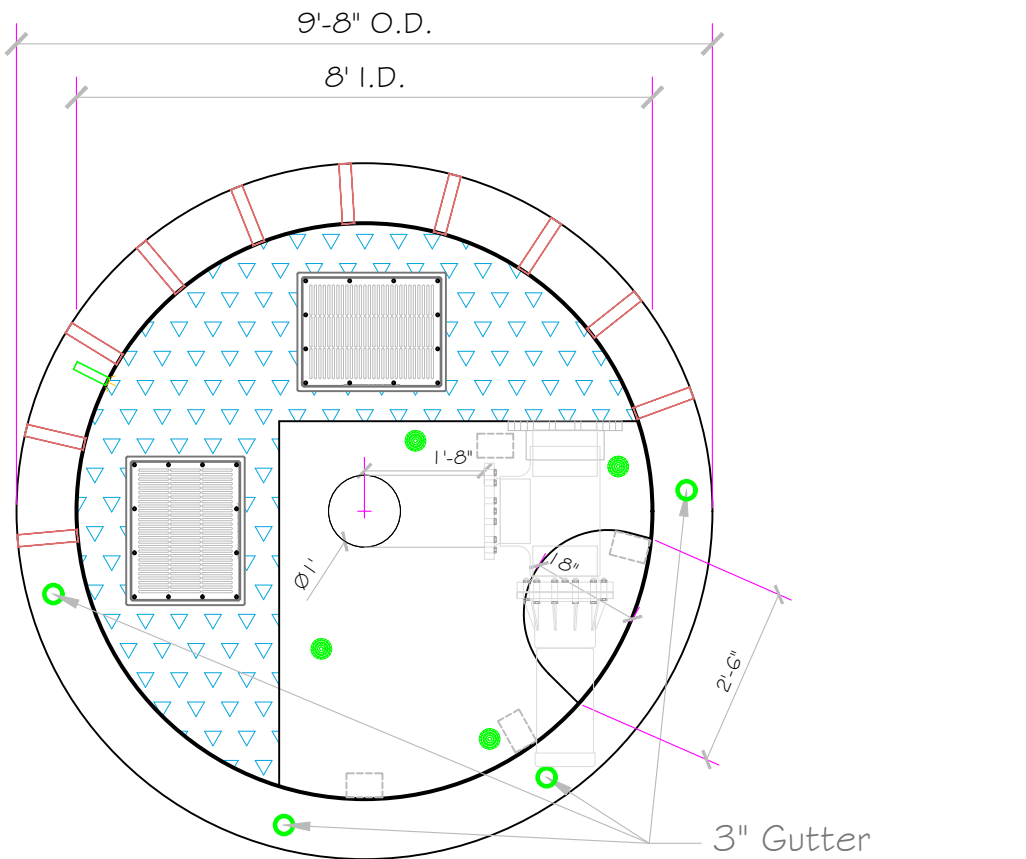

3" Gutter Drain Pipes (4)

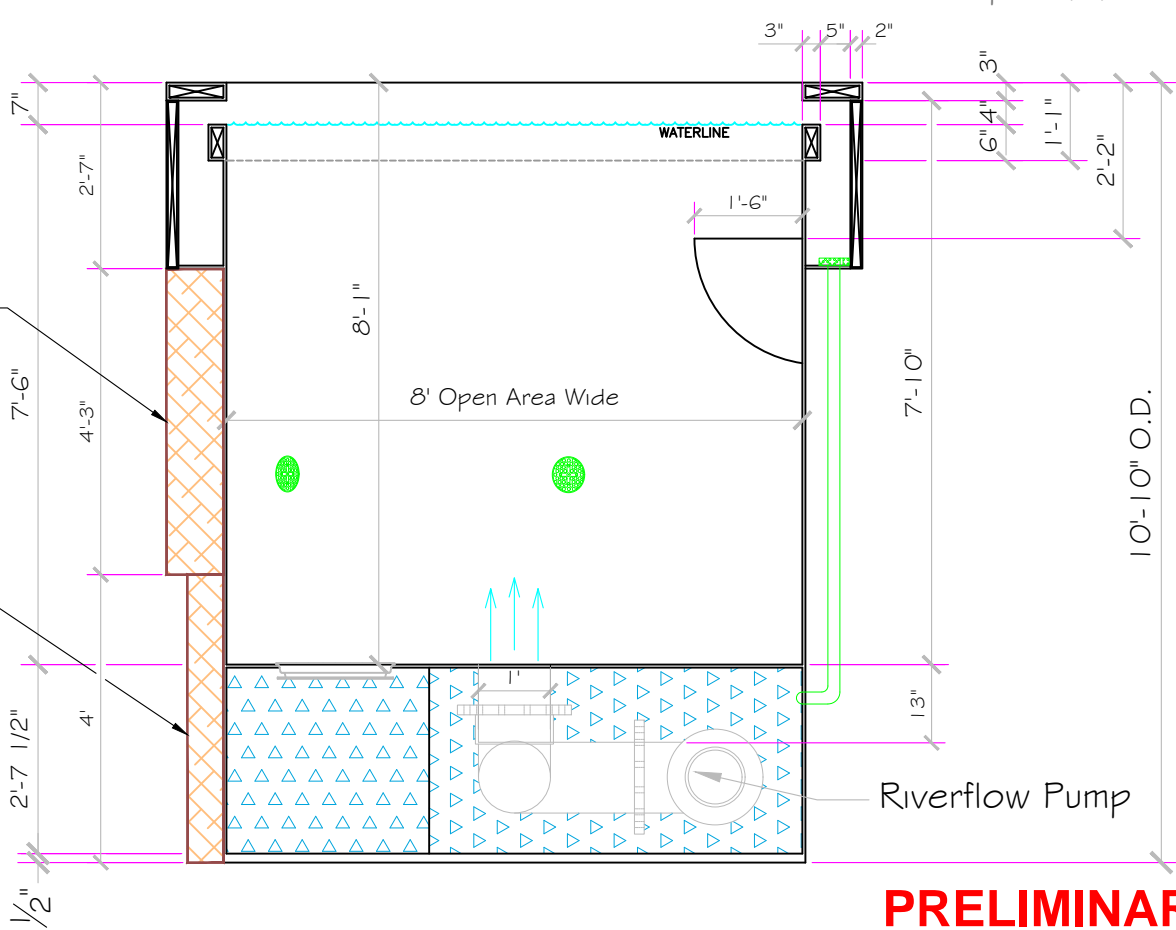

**PRELIMINARY**  
 ALL DIMENSIONS SUBJECT TO 1/4" TOLERANCES

**NESPA ENTERPRISES INC.**  
 2800 Richter Ave. Suite C Oroville, CA 95966  
 Office: (530) 534-9910 Fax: (530) 534-9915  
 E-Mail: [jim@tiledspas.com](mailto:jim@tiledspas.com) Web Site: [www.tiledspas.com](http://www.tiledspas.com)



If printing as a PDF:  
 Page Scaling:  None

DWG NAME TELFORD

SCALE 3/8" = 1'  
 DATE 4/17/2015

DWG TYPE Plunge  
 SHEET PAGE 1 OF 16

These drawings, concepts, and details contained herein are the original proprietary designs of NESPA ENTERPRISES INC., developed over many years of experience in the industry and as such are protected by the copyright laws of the United States Government. Reproduction of any of the above without written permission to do so by NESPA ENTERPRISES INC., is illegal.

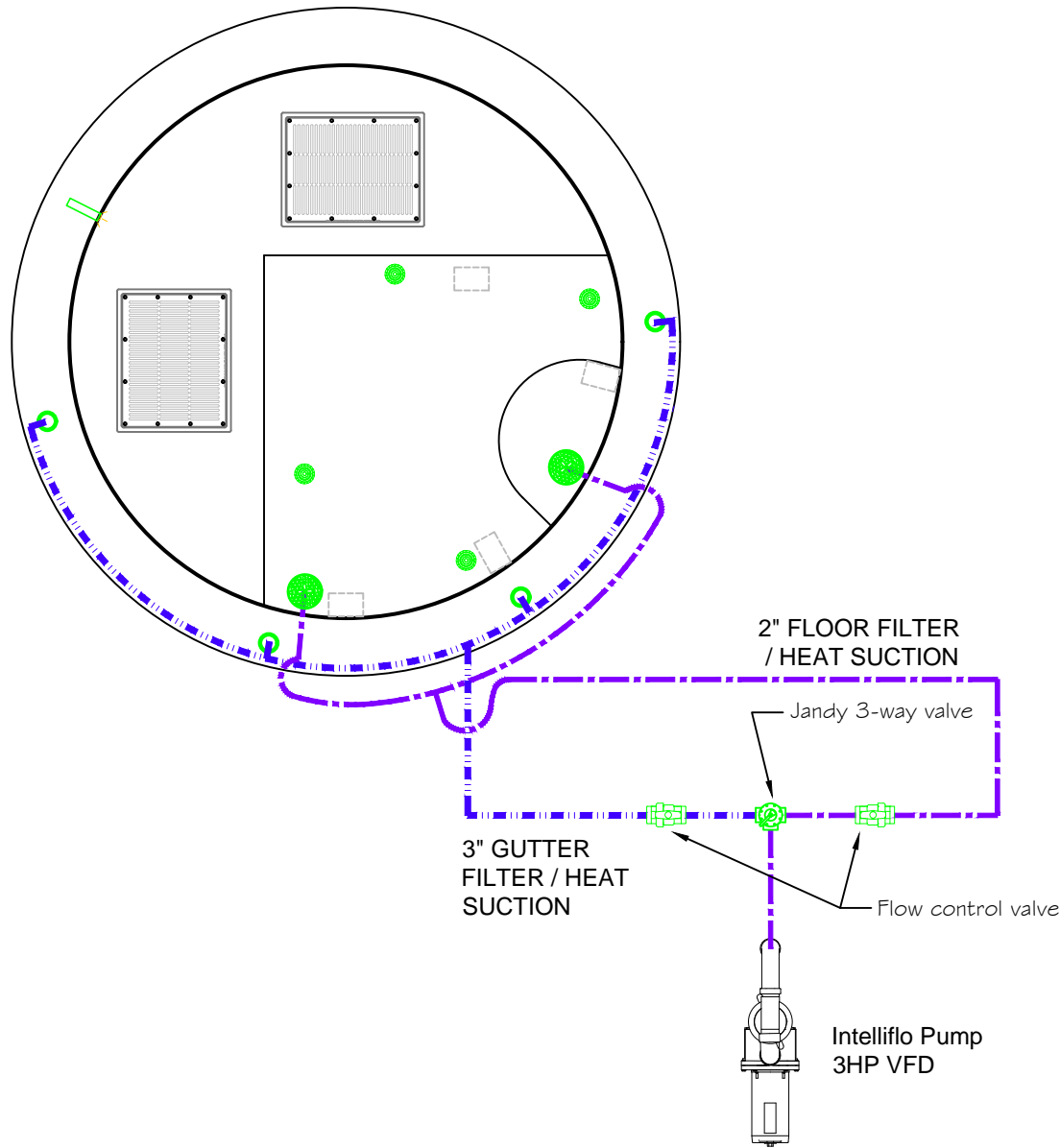

**PRELIMINARY**

ALL DIMENSIONS SUBJECT TO 1/4" TOLERANCES

These drawings, concepts, and details contained herein are the original proprietary designs of **NESPA ENTERPRISES INC.**, developed over many years of experience in the industry and as such are protected by the copyright laws of the United States Government. Reproduction of any of the above without written permission to do so by **NESPA ENTERPRISES INC.**, is illegal.

**NESPA ENTERPRISES INC.**

2800 Richter Ave. Ste. C Oroville, CA 95966

Office: (530) 534-9910

Fax: (530) 534-9915

E-Mail: [jim@tiledspas.com](mailto:jim@tiledspas.com) Web Site: [www.tiledspas.com](http://www.tiledspas.com)



If printing as a PDF:

Page Scaling:

SCALE

3/8" = 1'

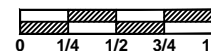

DWG TYPE

Plunge Suction Plumbing

DWG NAME

TELFORD

DATE

4/16/2015

SHEET

PAGE 2 OF 16

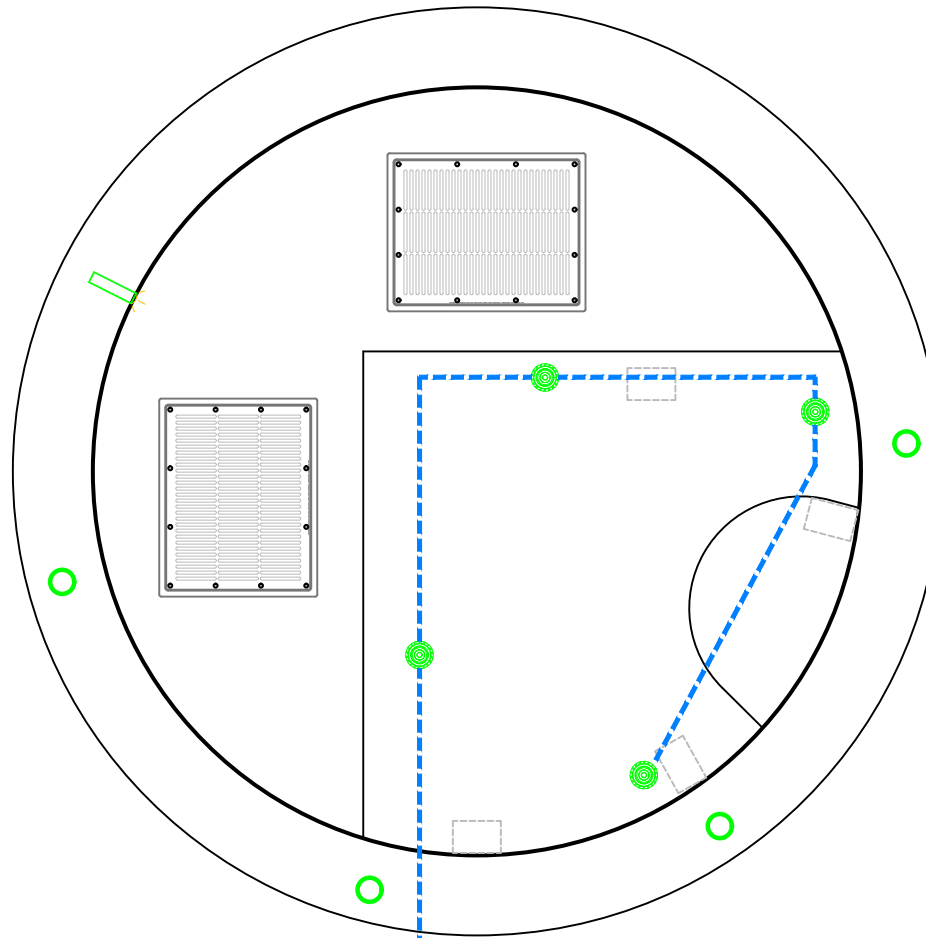

2-1/2" Filter Return

**PRELIMINARY**

ALL DIMENSIONS SUBJECT TO 1/4" TOLERANCES

These drawings, concepts, and details contained herein are the original proprietary designs of **NESPA ENTERPRISES INC.**, developed over many years of experience in the industry and as such are protected by the copyright laws of the United States Government. Reproduction of any of the above without written permission to do so by **NESPA ENTERPRISES INC.**, is illegal.

**NESPA ENTERPRISES INC.**

2800 Richter Ave. Ste. C Oroville, CA 95966

Office: (530) 534-9910

Fax: (530) 534-9915

E-Mail: [jim@tiledspas.com](mailto:jim@tiledspas.com) Web Site: [www.tiledspas.com](http://www.tiledspas.com)



**If printing as a PDF:**

Page Scaling:

SCALE

1/2" = 1'

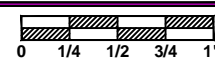

DWG TYPE

Plunge Return Plumbing

DWG NAME

TELFORD

DATE

4/16/2015

SHEET

PAGE 3 OF 16

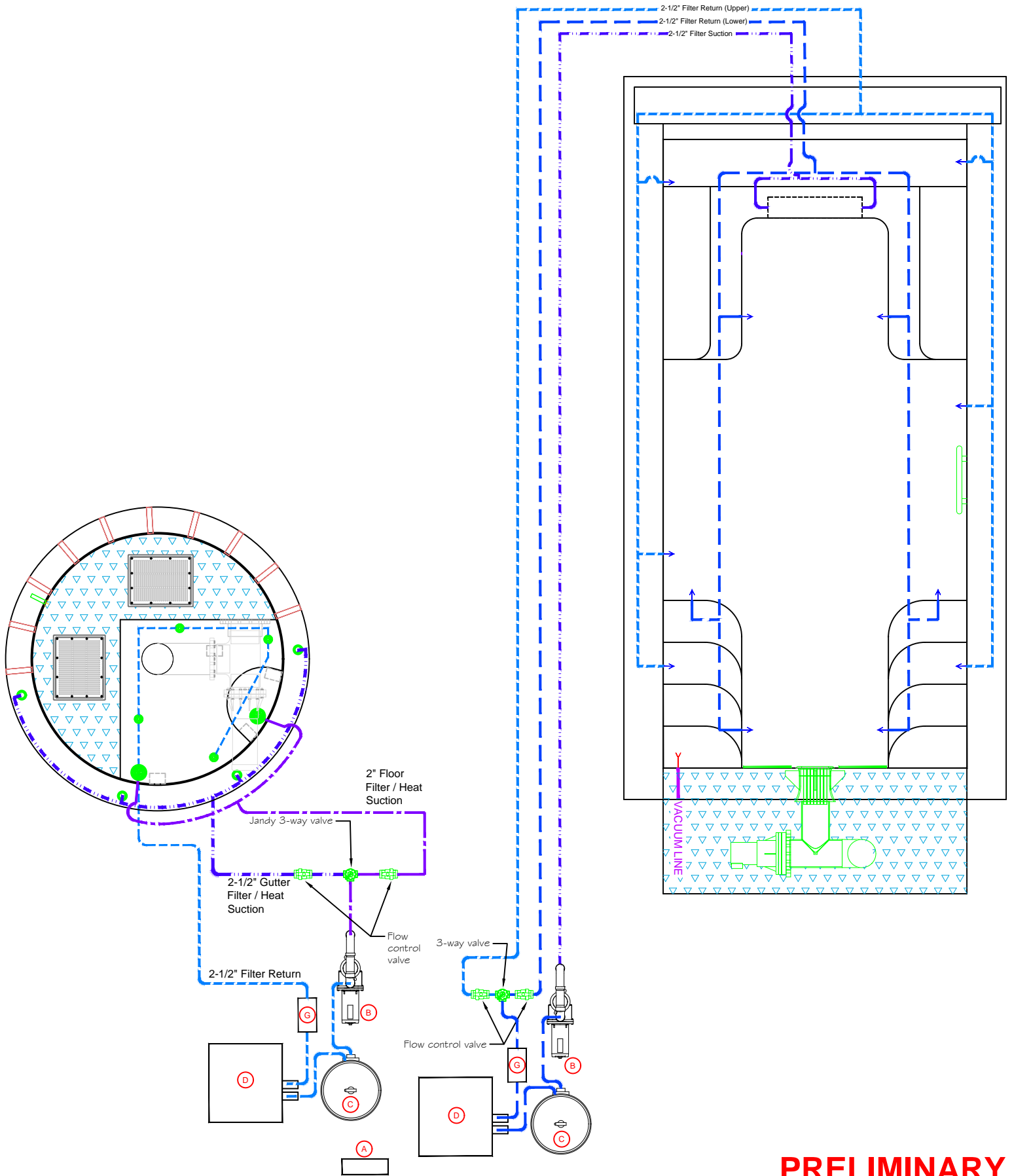

**PRELIMINARY**

ALL DIMENSIONS SUBJECT TO 1/4" TOLERANCES

**NESPA ENTERPRISES INC.**

2800 Richter Ave. Suite C Oroville, CA 95966

Office: (530) 534-9910 Fax: (530) 534-9915

E-Mail: [jim@tiledspas.com](mailto:jim@tiledspas.com) Web Site: [www.tiledspas.com](http://www.tiledspas.com)



If printing as a PDF:

Page Scaling:

DWG NAME

TELFORD

SCALE

1/4" = 1'

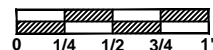

DWG TYPE

Plumbing Layout

DATE

4/16/2015

SHEET

PAGE 4 OF 16

These drawings, concepts, and details contained herein are the original proprietary designs of NESPA ENTERPRISES INC., developed over many years of experience in the industry and as such are protected by the copyright laws of the United States Government. Reproduction of any of the above without written permission to do so by NESPA ENTERPRISES INC., is illegal.

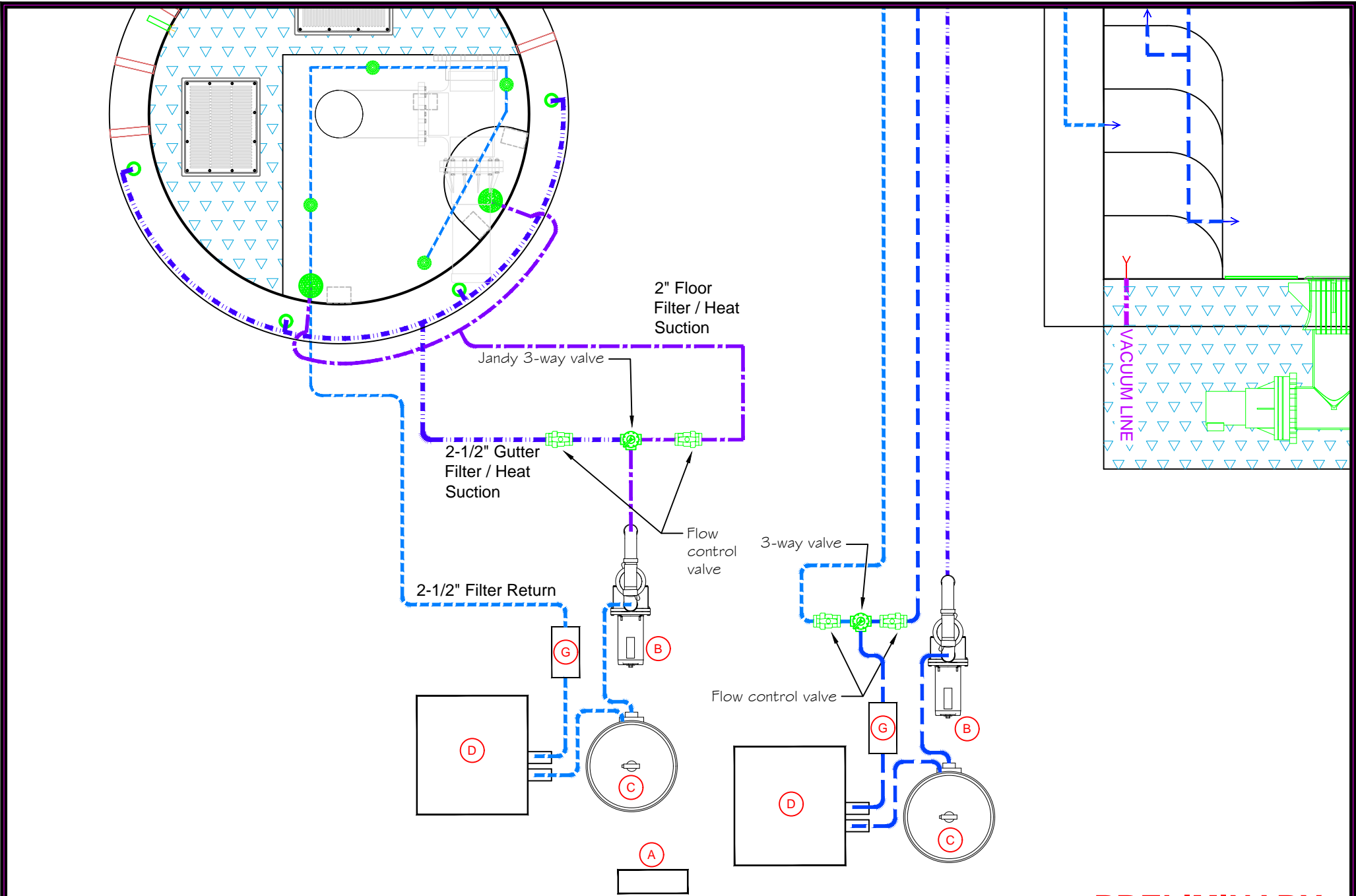

**PRELIMINARY**

ALL DIMENSIONS SUBJECT TO 1/4" TOLERANCES

These drawings, concepts, and details contained herein are the original proprietary designs of **NESPA ENTERPRISES INC.**, developed over many years of experience in the industry and as such are protected by the copyright laws of the United States Government. Reproduction of any of the above without written permission to do so by **NESPA ENTERPRISES INC.**, is illegal.

**NESPA ENTERPRISES INC.**  
 2800 Richter Ave. Ste. C Oroville, CA 95966  
 Office: (530) 534-9910 Fax: (530) 534-9915  
 E-Mail: [jim@tiledspas.com](mailto:jim@tiledspas.com) Web Site: [www.tiledspas.com](http://www.tiledspas.com)



**If printing as a PDF:**  
 Page Scaling:

SCALE  
 3/8" = 1'

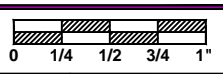

DWG TYPE  
 Plumbing Layout (2)

DWG NAME  
 TELFORD

DATE  
 4/16/2015

SHEET  
 PAGE 5 OF 16

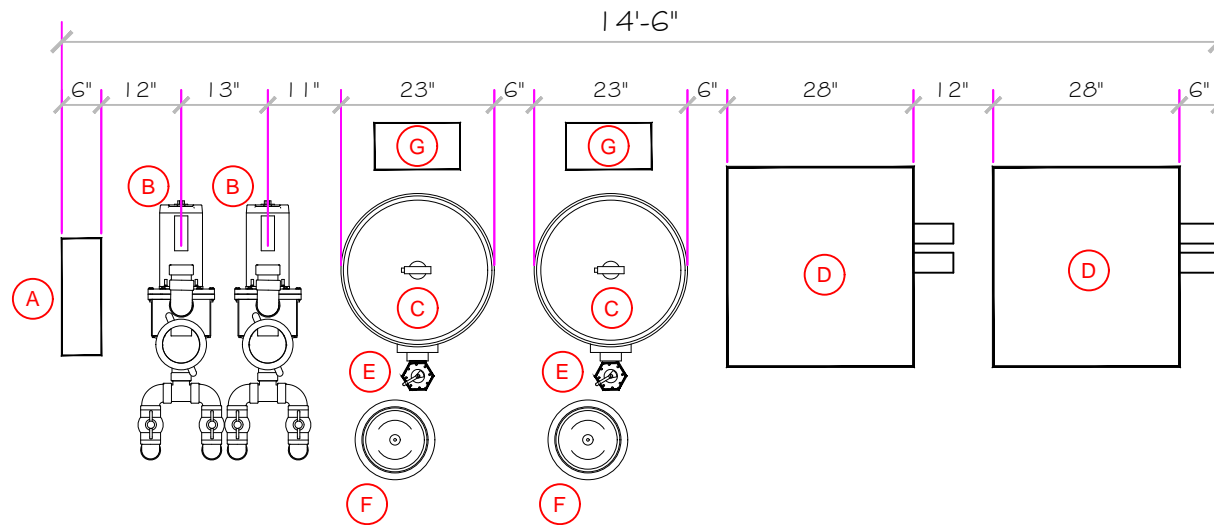

### EQUIPMENT LIST

ITEM	DESCRIPTION	MANUFACTURER	CATALOG NO.	QTY.
A	Intellitouch I9s plus 3 Dual Body Control System.	PENTAIR	x	1
B	Pentair Whisperflo XF 3HP	PENTAIR	022030	2
C	Pentair DE Filter FN5P48	PENTAIR	180008	2
D	Raypak Digital Propane Gas Heater R406A K BTU	RAYPAK	Ray-15-0205	2
E	Pentair DE Multiport Valve	PENTAIR	261055	2
F	Pentair Separation Tank 100 ( optional)	PENTAIR	SEP 100	2
G	Delzone Eclipse UV Ozone Generator	Delzone	x	2

**PRELIMINARY**

ALL DIMENSIONS SUBJECT TO 1/4" TOLERANCES

These drawings, concepts, and details contained herein are the original proprietary designs of **NESPA ENTERPRISES INC.**, developed over many years of experience in the industry and as such are protected by the copyright laws of the United States Government. Reproduction of any of the above without written permission to do so by **NESPA ENTERPRISES INC.**, is illegal.

**NESPA ENTERPRISES INC.**  
 2800 Richter Ave. Ste. C Oroville, CA 95966  
 Office: (530) 534-9910 Fax: (530) 534-9915  
 E-Mail: [jim@tiledspas.com](mailto:jim@tiledspas.com) Web Site: [www.tiledspas.com](http://www.tiledspas.com)



If printing as a PDF:

Page Scaling:

SCALE  
N/A

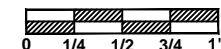

DWG NAME

TELFORD

DATE

4/20/2015

DWG TYPE  
Spa & Plunge EQ

SHEET  
PAGE 6 OF 16



## EQUIPMENT:

- 1.) Levelor w/2 Sensors - 200' CORD (GIP-56-1150)  
Zodiac Pool Systems K2300CKG for two bodies of water ( Qty 1)
- 2.) Swimspa and Spa Side Control - ( Qty 2) - 4-Button White 50 FT  
(COM-30-1883) Pentair Water Pool and Spa Inc (521883)
- 3.) Pentair - Load Center wo / transformer Intellitouch 115/230V (521215)
- 4.) Pentair - Personality Kit Pool/Spa Combo I9+3 Intellitouch - (521221)
- 5.) Raypak Heater - Raypak 399 BTU LP elec-cup nicc- r406a-ep-x-asme  
( Ray-15-0205) MFG# 010213 (Qty 2)
- 6.) Pentair - Intelliflow 3hp pumps- Pump 3HP 3PH 208-230/460V  
Whisperflo XF XFJ12 part # 022030

**PRELIMINARY**

ALL DIMENSIONS SUBJECT TO 1/4" TOLERANCES

### **NESPA ENTERPRISES INC.**

2800 Richter Ave. Suite C Oroville, CA 95966

Office: (530) 534-9910

Fax: (530) 534-9915

E-Mail: [jim@tiledspas.com](mailto:jim@tiledspas.com) Web Site: [www.tiledspas.com](http://www.tiledspas.com)



**If printing as a PDF:**

Page Scaling:

SCALE  
N/A

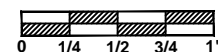

DWG TYPE

EQ

DWG NAME  
TELFORD

DATE  
4/23/2015

SHEET  
PAGE 6A OF 16

These drawings, concepts, and details contained herein are the original proprietary designs of [NESPA ENTERPRISES INC.](http://www.nespa.com), developed over many years of experience in the industry and as such are protected by the copyright laws of the United States Government. Reproduction of any of the above without written permission to do so by [NESPA ENTERPRISES INC.](http://www.nespa.com), is illegal.

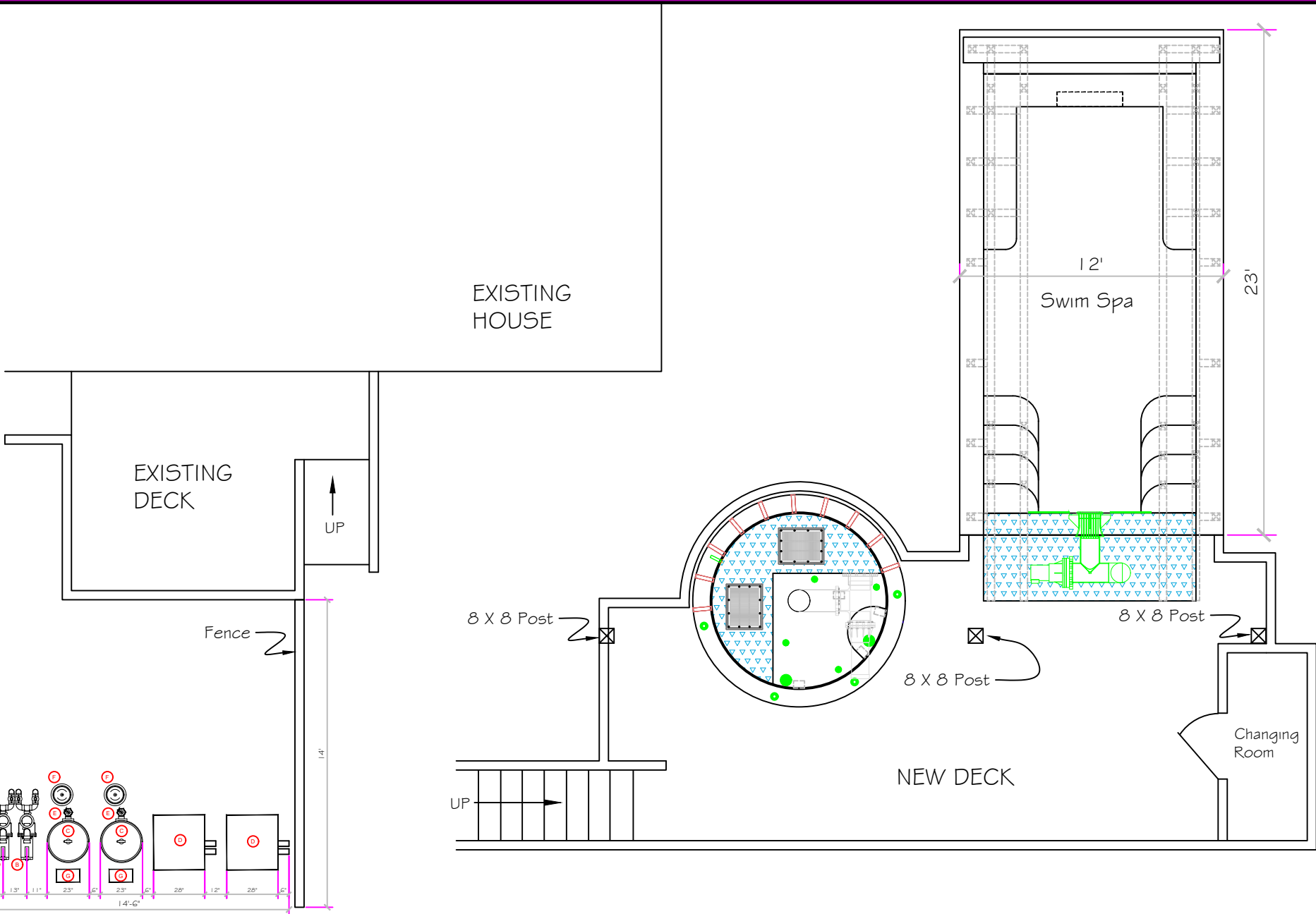

**PRELIMINARY**

ALL DIMENSIONS SUBJECT TO 1/4" TOLERANCES

These drawings, concepts, and details contained herein are the original proprietary designs of **NESPA ENTERPRISES INC.**, developed over many years of experience in the industry and as such are protected by the copyright laws of the United States Government. Reproduction of any of the above without written permission to do so by **NESPA ENTERPRISES INC.**, is illegal.

**NESPA ENTERPRISES INC.**  
 2800 Richter Ave. Ste. C Oroville, CA 95966  
 Office: (530) 534-9910 Fax: (530) 534-9915  
 E-Mail: [jim@tiledspas.com](mailto:jim@tiledspas.com) Web Site: [www.tiledspas.com](http://www.tiledspas.com)



If printing as a PDF:  
 Page Scaling:

SCALE  
 N/A

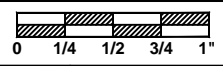

DWG TYPE  
 Spa & Plunge Layout

DWG NAME  
 TELFORD

DATE  
 4/16/2015

SHEET  
 PAGE 7 OF 16



**PRELIMINARY**

ALL DIMENSIONS SUBJECT TO 1/4" TOLERANCES

These drawings, concepts, and details contained herein are the original proprietary designs of **NESPA ENTERPRISES INC.**, developed over many years of experience in the industry and as such are protected by the copyright laws of the United States Government. Reproduction of any of the above without written permission to do so by **NESPA ENTERPRISES INC.**, is illegal.

**NESPA ENTERPRISES INC.**  
 2800 Richter Ave. Ste. C Oroville, CA 95966  
 Office: (530) 534-9910 Fax: (530) 534-9915  
 E-Mail: [jim@tiledspas.com](mailto:jim@tiledspas.com) Web Site: [www.tiledspas.com](http://www.tiledspas.com)



**If printing as a PDF:**  
 Page Scaling:

SCALE  
 N/A

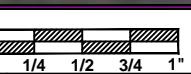

DWG TYPE  
 EQ Layout

DWG NAME  
 TELFORD

DATE  
 4/16/2015

SHEET  
 PAGE 8 OF 16

## Anything But Basic

### Cabinet

- Outdoor too - (standard)
- Wind resistant design
- Charnes rainwater out
- Textured powder-coat finish
- Optional indoor top

### Digital Controls

- Microprocessor-controlled
- Built-in diagnostics
- Backlit LCD display
- Pool and spa settings
- Lexan cover with snap closure
- Remote controllable
- Flame strength meter
- Cycle and run time log
- Transmitter output monitor
- Fault history list 10

### Burner Tray

- Easily removable
- Stainless steel burners
- Brass orifices
- Aluminized metals
- Stainless steel heat shield
- Sparks to pilot ignition
- Soft opening gas valve

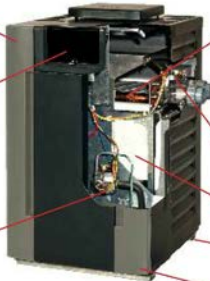

### Heat Exchanger

- Integral copper fin tube - (standard)
- Automatic bypass
- Linlithum governor
- Polymer headers
- Stainless steel tube sheet
- Reversible for left-side water connections.
- ASME - (optional)
- Cupro-nickel - (optional)

### 2" CPVC Connections

- High Limits and Controls
- Mounted on the inlet header

### Ceramic Fiber Combustion Chamber

- Non-Combustible Base
- Heater can be installed on a combustible surface

### Base - Interior Floor

- Stainless steel

### 120/240V

- Incoming power can be connected to the right or left side.

Model	copper (polymer headers) ASME copper and cupro	cupro-nickel (polymer headers)
206	199,500	180,000
266	266,000	240,000
336	332,500	300,000
406	399,000	260,000

## Optional D-2 Power Vent

### D-2 Power Vent

Sometimes, equipment rooms or unusual venting configurations require the use of a power vent. Being the heater experts, we have this option for you when the need may arise.

### Through-the-Wall Capable

The D-2 Power Vent assembly is a Category III mechanical draft venting system that operates under a positive static pressure and prevents excessive condensate production in the vent. All sizes are capable of relieving flue gases up to a maximum of 100 equivalent feet of vent length. All models have a standard 4" diameter exhaust connector.

### Multi-Position

Using the Raypak-supplied adjustable 90° elbow, the flue gases may be discharged in any direction (see D-2 Power Vent manual for details). The D-2 Power Vent is also dual-voltage capable (120/240 volt) and engineered for long life and smooth operation.



D-2 Power Vent

For dimensions and technical specifications, see catalog number 6000.35.

In use with the 120/240 volt heater also requires an electrical permit. Proper venting is required. See manual for details.



Raypak, Inc., 1211 Seibert Avenue, Denver, CO 80202, 303.274.5500 Fax 303.274.5505  
www.raypak.com



Made in U.S.A. ©2009-2013 Raypak, Inc. Catalog No. 6000.120 Effective 07-01-13 Replaces 02-10-13

## INTELLIFLO® VARIABLE SPEED PUMP

### Proven dependability that's in a class by itself.

IntelliFlo pumps have amassed a record of field-proven reliability that's unmatched by any other variable speed pump. Here's how:

- Permanent magnet motor runs cooler, produces less vibration than induction motors.
- Totally enclosed fan-cooled (TEFC) design protects against the elements.
- Built-in diagnostics protect the pump for longer service life.

So when you invest in the superior engineering of an IntelliFlo pump, you'll reap the dividends for years to come. Visit your Pentair professional, now... and let the enjoyment begin.

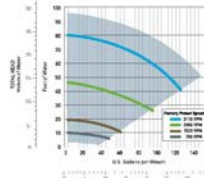

NOTE: This is an example flow rate for the IntelliFlo pump. Actual flow rate will vary based on system head pressure, pipe size, and other factors. IntelliFlo pumps are available in a range of sizes from 1/2" to 2" NPT. See IntelliFlo pump manual for details.

### How does your pump measure up to the IntelliFlo pump?

#### IntelliFlo pumps vs. single-speed pumps

Benefit	IntelliFlo Variable Speed Pump	Single-Speed Pumps
Up to \$1,500 estimated cost savings each year!	YES	NO
Energy savings up to 90%	YES	NO
Longer pump life	YES	NO
Permanent magnet motor, as in hybrid cars, reduces noise and vibration	YES	NO
Improves filter and chlorinator performance	YES	NO
Helps reduce algae build-up	YES	NO
Lets you add pool features without reducing pump efficiency	YES	NO
Totally enclosed fan-cooled (TEFC) design protects working parts	YES	NO
Built-in diagnostics protect the pump for longer service life	YES	NO
8 programmable speed settings and built-in timer assure optimum speed and run times for maximum efficiency and savings	YES	NO

#### IntelliFlo pumps vs. other variable speed pumps

Benefit	IntelliFlo Variable Speed Pump	Other Variable Speed Pumps
World's first-ever variable speed pump	YES	NO
More total energy savings than any other pump family in history	YES	NO
Nearly a decade of proven-in-field reliability	YES	NO
Outwells all other variable speed pumps combined	YES	NO

AVAILABLE FROM:



1620 HAWKINS AVE., SANFORD, NC 27330 800.631.7133 WWW.PENTAIRPOOL.COM

IntelliFlo pumps are designed for use in pools and spas. They are not intended for use in hot tubs, whirlpools, or other applications. IntelliFlo pumps are not intended for use in applications where the water is not clean. IntelliFlo pumps are not intended for use in applications where the water is not clean. IntelliFlo pumps are not intended for use in applications where the water is not clean.

pumps • filters • heaters • heat pumps • automation • lighting • cleaners • sanitizers • water features • maintenance products

©2013 Pentair, Inc. All rights reserved. IntelliFlo is a registered trademark of Pentair, Inc.

## QUAD D.E.® CARTRIDGE STYLE FILTER

Fiberglass-reinforced polypropylene tank for long life will not corrode

2" plumbing connections for maximum flow

1 1/2" drain for easy and efficient cleanup and 100% draining



### THE HIGHEST WATER CLARITY WITH THE LOWEST AMOUNT OF FUSS

The Quad D.E. filter combination of diatomaceous earth (D.E.) and cartridge element convenience means better performance and superior water clarity. Because D.E. removes the tiniest of contaminants—particles as small as five microns—you can count on clean, crystal-clear water for years to come.

- Manual air relief valve and continuous internal air relief work together for maintenance-efficient filtration.
- Durable 8-oz. woven polypropylene cartridge media have super-slick surfaces, making them easier to clean than conventional cartridge filters.
- Attractive almond-colored tank blends into any backyard environment.



Cartridges are designed with slick surfaces so dirt easily rinses off. Remove and rinse or rinse in place. Or, backwash and recharge like a traditional D.E. filter.

Note: Must use a Hi-Flow™ Backwash Valve (Part # 261350) or Side Valve (Part # 263034 or Part # 263064) when plumbing filter with a backwash valve (Part # 261350).

Model Number	Filter Area Sq. Ft.	Vertical Clearance*	Filter Diameter	Flow Rate GPM		Turnover Capacity (Gallons)		
				Res.	Carom.	8 hrs.	10 hrs.	12 hrs.
Quad 60	60	64"	21.5"	120	120	37,400	72,000	86,800
Quad 80	80	68"	21.5"	140	150	76,800	96,000	115,200
Quad 100	100	74"	21.5"	160	150	76,800	96,000	115,200

\* Required clearance to the top of the filter. \*\* Maximum flow rate.

AVAILABLE FROM:



1620 HAWKINS AVE., SANFORD, NC 27330 800.631.7133 WWW.PENTAIRPOOL.COM

Quad D.E. filters are designed for use in pools and spas. They are not intended for use in hot tubs, whirlpools, or other applications. Quad D.E. filters are not intended for use in applications where the water is not clean. Quad D.E. filters are not intended for use in applications where the water is not clean.

pumps • filters • heaters • heat pumps • automation • lighting • cleaners • sanitizers • water features • maintenance products

©2013 Pentair, Inc. All rights reserved. IntelliFlo is a registered trademark of Pentair, Inc.

These drawings, concepts, and details contained herein are the original proprietary designs of **NESPA ENTERPRISES INC.**, developed over many years of experience in the industry and as such are protected by the copyright laws of the United States Government. Reproduction of any of the above without written permission to do so by **NESPA ENTERPRISES INC.**, is illegal.

**NESPA ENTERPRISES INC.**  
2800 Richter Ave. Ste. C Oroville, CA 95966  
Office: (530) 534-9910 Fax: (530) 534-9915  
E-Mail: [jim@tiledspas.com](mailto:jim@tiledspas.com) Web Site: [www.tiledspas.com](http://www.tiledspas.com)



If printing as a PDF:  
Page Scaling: None  
DWG NAME: TELFORD

SCALE: N/A  
DATE: 3/10/2015

DWG TYPE: EQ Info  
SHEET: PAGE 9 OF 16

**PRELIMINARY**

ALL DIMENSIONS SUBJECT TO 1/4" TOLERANCES

# Riverflow® Pump by Current Systems Inc.

Performance • Reliability • Innovative Propeller Pump Technology

Designed Specifically for Lazy Rivers and High Capacity Water Features

### Features:

- Electronic Variable Speed Control
- Ultra High Flow Rate
- Low Operating Cost
- Programmable Timer
- Extremely Quiet Operation
- Single & Three Phase Applications
- Low Maintenance
- 5-year Warranty
- Design and Application Support



• Suction & Return Ranges Optional

### Riverflow Performance

	*F/S	MPH	GPM	AMP 230V	AMP 480V
10 HP	10	6.8	2450	27	13.5
7.5 HP	8.5	5.8	2050	22	11
7.5 HP Ultra Premium	10	6.8	2450	22	11

### Programmable Display



- Local/Remote Indication
- Motor rotation indicator
- Speed Reference
- Actual value 1, Process value (selectable)
- Actual value 2, Output current (selectable)
- Actual value 3, Actual motor speed (selectable)
- Real time clock

### Riverflow Pump Performance Curve

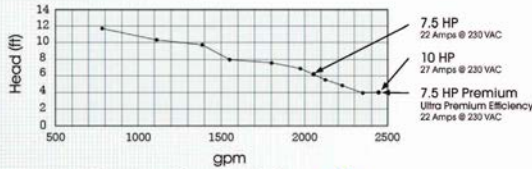

866-372-8886 • www.riverflowpumps.com • technical@current-systems.com

# Riverflow® Pump by Current Systems Inc.

Premium Variable Frequency Drive

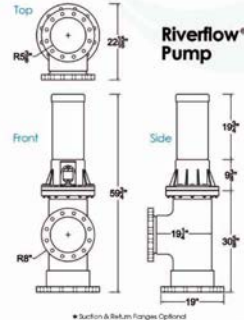

• Suction & Return Ranges Optional

### Premium Variable Frequency Drive



### Features Include:

- Real Time and Historical Data
- Pool Automation Interface
- Control Panel with
  - Start-Up, Maintenance and Diagnostic Assistants
  - Support for 15 Languages
  - Full Graphic Display
  - "Help" Button
- Fieldbus adapters for serial communications
- UL, cUL and CE Approved

### Protection

- Overcurrent
- Ground Fault
- Overtemperature
- Auxiliary Voltage Short Circuit Protection
- Electronic Motor Overload (UL508C - I2T)
- Overvoltage
- Undervoltage
- Microprocessor Fault
- Motor Stall
- Underload

Contact us for design or technical information

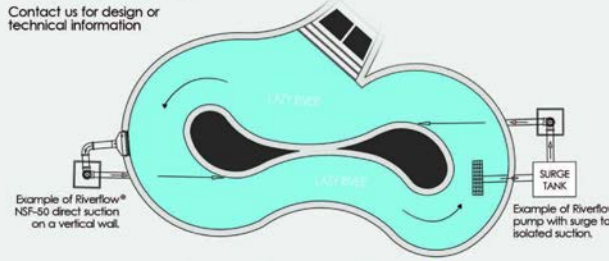

866-372-8886 • www.riverflowpumps.com • technical@current-systems.com

### Riverflow Pump

Actual Flow (propeller) 10"  
 Maximum System Pressure Typical 2.5 PSI Competition Model  
 Maximum System Pressure Typical 1.5 PSI Elite  
**Suction**  
 Flooded non self priming flooded suction /NPSHR > 1 foot Supply Pipe Velocity < 8 f/s  
**Safety**  
 Supply Safety Grate ANSI Compliant (A112.19.8M /A24.2.6.6.2 # 2)  
 Safety Grate dimensions /756 sq in. (Max Opening .375x .375)  
 Velocity through grate @ 3000 gpm < 1.5 f/s

Hair Entanglement/Entrapment (as noted by IAMPO SPS 1-83,CPSC, NSPENSPFI)  
 Tested at < 1lb pull per and  
 Wig Flotation Per ANSI < than 5 seconds  
 Full Body Obstruction no measurable attraction

Elite Model 20.4 Amps @ 230 VAC  
 Motor Lesson UL File # E57955  
 ABB Drive UL File # E124534

GF/Motor Thermal Overload  
 Line Reactor Over Current Over  
 Voltage Under Current Under Voltage

Competition Model 26 Amps @ 230 VAC  
 Motor Lesson UL File # E57955  
 ABB Drive UL File # E124534

GF/Motor Thermal Overload  
 Line Reactor Over Current Over  
 Voltage Under Current Under Voltage

Hydraulics 12" Suction Supply Line  
 Velocity Flow Rate 0-3000 GPM Competition Model  
 Through Grate Flow Rate 0-2400 GPM Elite Model  
 < 1.5 f/s

Maximum Suction Velocity 8.4 f/s  
 Suction Grate Area 756 Sq In.

Safety Compliant ANSI A112.19.8M  
 ANSI Exception 424.2.6.2  
 Hair Entrapment < 1 LB Pull

Current Systems Inc.  
 23679 Calabasas Road Unit 548  
 Calabasas, California 91302  
 Toll Free 866-372-8886 Fax 818-991-4227  
 www.current-systems.com

### Pump Curves

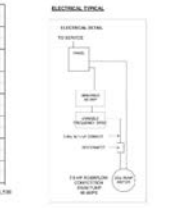
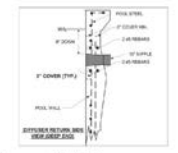
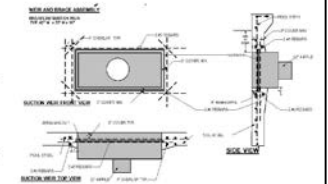
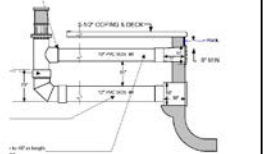
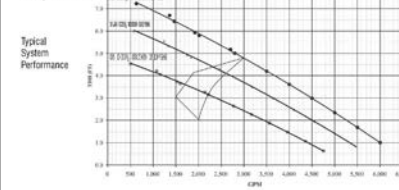

**PRELIMINARY**

ALL DIMENSIONS SUBJECT TO 1/4" TOLERANCES

These drawings, concepts, and details contained herein are the original proprietary designs of **NESPA ENTERPRISES INC.**, developed over many years of experience in the industry and as such are protected by the copyright laws of the United States Government. Reproduction of any of the above without written permission to do so by **NESPA ENTERPRISES INC.**, is illegal.

**NESPA ENTERPRISES INC.**  
 2800 Richter Ave. Ste. C Oroville, CA 95966  
 Office: (530) 534-9910 Fax: (530) 534-9915  
 E-Mail: [jim@tiledspas.com](mailto:jim@tiledspas.com) Web Site: [www.tiledspas.com](http://www.tiledspas.com)



If printing as a PDF:  
 Page Scaling: None  
 DWG NAME TELFORD

SCALE N/A  
 DATE 3/10/2015

DWG TYPE Riverflo  
 SHEET PAGE 10 OF 16

# STANDARD NESPA IN-GROUND INSTALLATION INSTRUCTIONS **SET-UP AND EXCAVATION**

**Prerequisites:** Before installing your Nespa spa. You may be required to acquire a permit from your local State, County, and City building dept and or Health department. (Commercial jobs need Health Dept. Approval). Your spa installation must comply with the most current codes. ( **Uniform Swimming Pool, Spas & Hot Tub Code 2006 ( USPC 2006)**).

**Spa drawings:** Request from Nespa a current spa specific construction detail, plan and section, spa plumbing detail.

**Delivery Access:** Clearly determine the method of getting the spa to jobsite and into the hole. This may require the use of a crane, forklift, hoist, backhoe and/or manpower etc.

- 1) The following instructions are general guidelines and may not apply to your specific jobsite conditions. When excavating for your spa remember to provide for plumbing and light connection clearances. In order to determine how to excavate for your spa or swim spa, measure spas outside dimension ( O.D.) and add minimum 3” to all sides. This 3” clearance is to accommodate jet and suction plumbing. This 3” clearance can change or be reduced upon request. Note: skimmer location, this area may have to be larger than 3”, if commercial 22”.
- 2) **Freeze Climates-** If the spa is place into a vault (typical of freeze climates) a standard 18” or more of clearance minimum from spa perimeter should be provided. This dead air space is for possible future access to spa plumbing in case of a freeze. Area drain is mandatory. **Ask your local installer** for his experienced opinion. Do not hesitate to call us because we want to be sure that your installation progresses as smoothly as possible. If you have questions call us. (888) 479-4677.
- 2) **Hole depth** is determined by spa’s outside height dimension. This height may vary depending if spa has skids or no skids. The spa lip may be finished or non- finished. How is the perimeter deck elevation transitioning to the spa? Focus on the finish surrounding deck elevations, thickness of the finish material on spa upper horizontal lip, equal to lip or under the spa lip. This material can be tile, stone, concrete or brick.
- 3) **Preplumb** the spa before it goes into the hole. If there are needs for electrical , bonding or control conduits run them as well before dropping in hole. Connect bond wire to niche would be best.
- 4) **Spa should sit on level 3 ½” thick reinforced concrete pad. Sweep debris off pad prior to dropping in hole.**
- 5) **Install spa** into the hole on top of concrete pad. Use the Eye bolts provided for crane, forklift etc. rigging. Do not hold onto pipes. Use caution with suction and jet plumbing when lowering into hole. **DO NOT STRESS FITTINGS!** Fill Spa with water and check for leaks prior to backfill.

- 6) **Check site reference** points for proper spa positioning (i.e., squaring to house, garage, etc.).
- 7) **Shim to level spa.** Shim with non-compression able material. Re square to house, or ref. point.
- 8) **Dry pack** with cement the gaps that have been created when shimming spa level.
- 9) **Connect pipes to tees** if spa is preplumb. Installers properly support your new plumbing from stressing spas preplumb fittings. After electrical conduit and bond wire is connected to light niche, water test spa before back filling with sand.  
**NOTE: All Nespa products are water tested prior to leaving factory.**

### **ELECTRICAL:**

- 1) All electrical connections to spa or equipment should comply with the most recent national electrical code (NEC), state and local codes.
- 2) Connect electrical conduit to light niche. This work should be done or reviewed by a licensed electrician.
- 3) To install spa light you will need to include inside the PVC conduit to the light niche a solid #8 coated copper wire. (If you are use brass conduit, internal bond wire is not required.) This bond wire should be pulled with the light cord at the same time. This bond wire needs to be attached to the internal bonding lug of the light niche. An approved encapsulate should be applied to bond wire connection in niche.
- 4) An external #8 copper wire shall be connected to the external bonding lug on the rear of the light niche. This copper wire can then be used for additional bonding requirements (i.e., handrails or any other metallic object within 5' of the spa.

### **PLUMBING:**

- 1) **When plumbing a Nespa it is important to properly size the plumbing. We highly recommend that you follow the pump manufacturer's pipe sizing requirements and Uniform Swimming Pool, Spas & Hot Tub Code 2006 ( USPC 2006). This code book is available at [www.JAPMO.org](http://www.JAPMO.org) or (909) 472 4100.**
- 2) The jet air venturi should be a Hartford loop design adjacent to spa shell and air entry point can be located next to spa or remotely at equipment.
- 3) Fill spa with water and test the system for leaks PRIOR to backfilling with sand.

### **SAND BACK FILL:**

- 1) **With water in spa, back-fill around spa perimeter with dry plaster sand and wet wash with hydraulic attachment to hose. Let set for one hour and hydraulic dry again. Be sure water level in spa is at the highest level. Any questions please call us. ( 888) 479-4677.**
- 2) **If spa is free standing on elevated deck or a structure, it is important to fill spa with water and load area prior to installing coping or perimeter decking. If spa is installed in a vault situation a area drain is needed.**

**NESPA ENTERPRISES INC.**

2800 Richter Ave. Suite E

Oroville, CA 95966

Office: (888) 479-4677 Fax: (530) 534-9915

E-Mail: nespa@pacbell.net www.tiledspas.com

**IN-GROUND**

**INSTALLATION**

\*ALL DIMENSIONS SUBJECT TO 1/4" TOLERANCES\*

SCALE: 1/2" = 1'-0"

DATE: 3/27/02

JOB : STANDARD INSTALL

DW #: SI-1, SI-2

**NOTE:**

Sump pump or gravity drain is required for removing water from vault

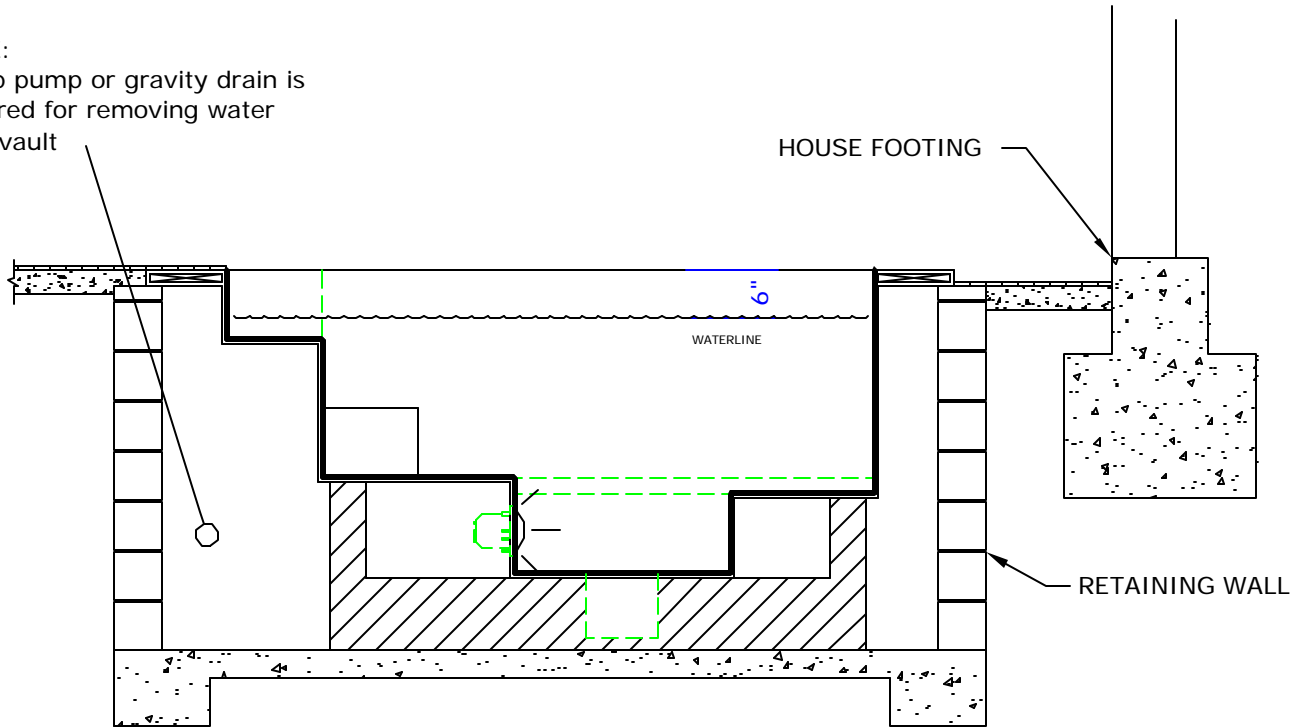

**STANDARD VAULT INSTALLATION**

SI-1

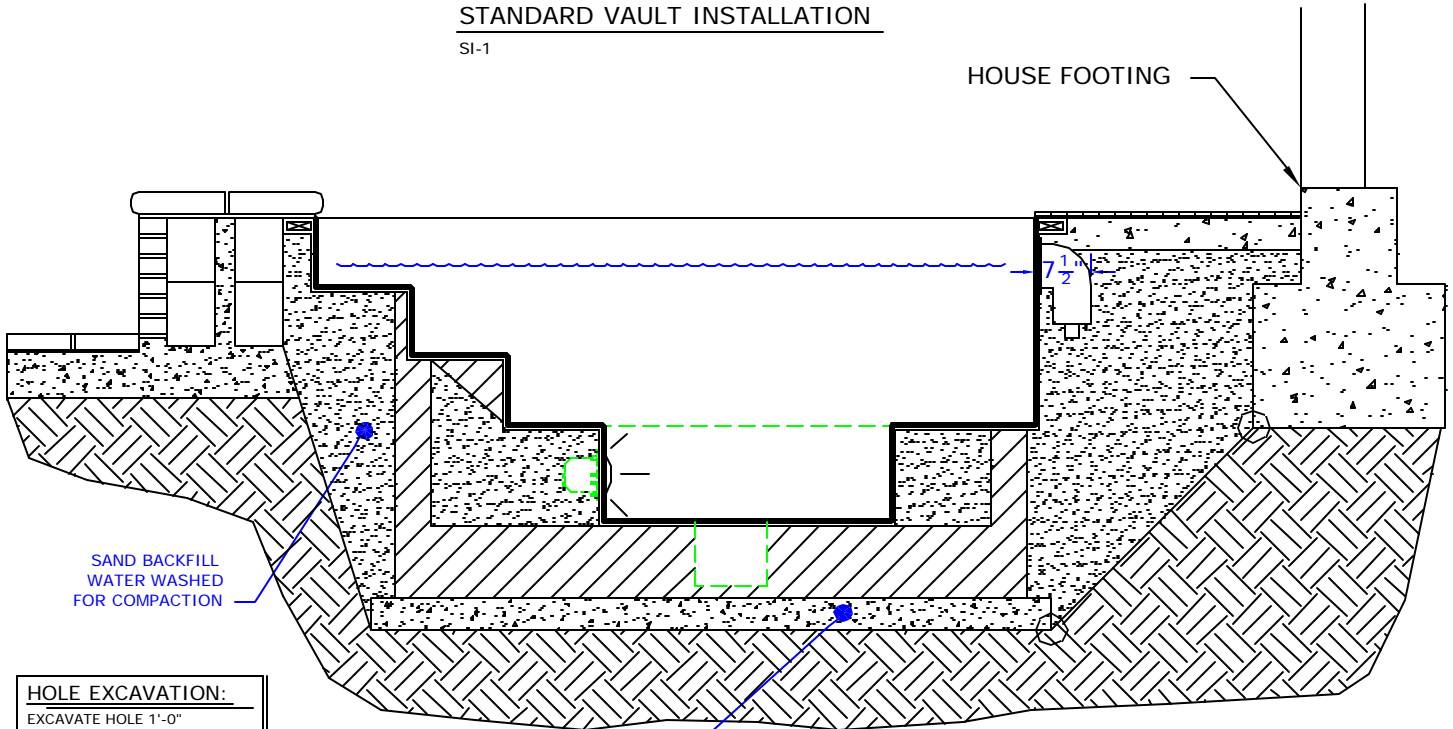

SAND BACKFILL  
WATER WASHED  
FOR COMPACTION

**HOLE EXCAVATION:**  
EXCAVATE HOLE 1'-0"  
LARGER THAN THE OUTSIDE  
DIAMETER (OD) OF SPA

4" CONCRETE SLAB  
REINFORCED WITH  
#10 MESH

**STANDARD INGROUND INSTALLATION**

SI-2

**NOTE:**

Footing can not surcharge spa.  
Slope from bottom of slab to  
nearest corner of house footing  
must not exceed 1" = 1".



# POOL BONDING REQUIREMENTS:

1. THE FOLLOWING PARTS SHALL BE BONDED TOGETHER AND CONNECTED TO THE COMMON BONDING GRID.
  - A. ALL THE METALLIC PARTS OF THE POOL STRUCTURE INCLUDING COPING STONES, DECK, PERMANENT PLAY STRUCTURES, PERMANENT EXERCISE STRUCTURES.
  - B. ALL METAL FITTINGS WITHIN OR ATTACHED TO THE POOL STRUCTURE
  - C. METAL PARTS ASSOCIATED WITH THE POOL WATER CIRCULATING SYSTEM, INCLUDING PUMPS, FILTERS, AND HEATERS.
  - D. METAL PARTS ASSOCIATED WITH POOL COVERS
  - E. METAL SHEATHED CABLES AND RACEWAYS, METAL PIPING AND ALL FIXED METAL PARTS WITHIN 5 FEET HORIZONTALLY OF INSIDE WALLS OF POOL AND WITHIN 12 FEET ABOVE MAXIMUM WATER LEVEL OF POOL.
  - F. METAL PARTS ASSOCIATED WITH OBSERVATION STANDS, TOWERS, PLATFORMS, AND DIVING STRUCTURES.
2. BONDING CONDUCTORS SHALL BE MINIMUM #8 SOLID COPPER, INSULATED E.C. SHALL COORDINATE APPROVED CONNECTOR TYPE AND METHOD WITH LOCAL ELECTRICAL AND/ OR POOL INSPECTOR.
3. SPECIFIC MANUFACTURER'S INSTRUCTIONS REGARDING BONDING OR GROUNDING OF POOL EQUIPMENT, WHETHER INDICATED HEREIN OR NOT, SHALL BE STRICTLY FOLLOWED.
4. THE COMMON BONDING GRID SHALL NOT BE CONNECTED TO ANY ELECTRICAL DISTRIBUTION EQUIPMENT.
5. ANY PARTS IN ADDITION TO THOSE DESCRIBED HEREIN THAT ARE INDICATED BY POOL CONTRACTOR OR LOCAL INSPECTION AUTHORITY SHALL BE BONDED TO THE COMMON BONDING GRID WITH NO ADDITIONAL COSTS INCURRED BY THE OWNER.
6. THE ELECTRICAL CONTRACTOR SHALL COORDINATE BONDING WITH GENERAL CONTRACTOR.

# LIGHT DETAIL

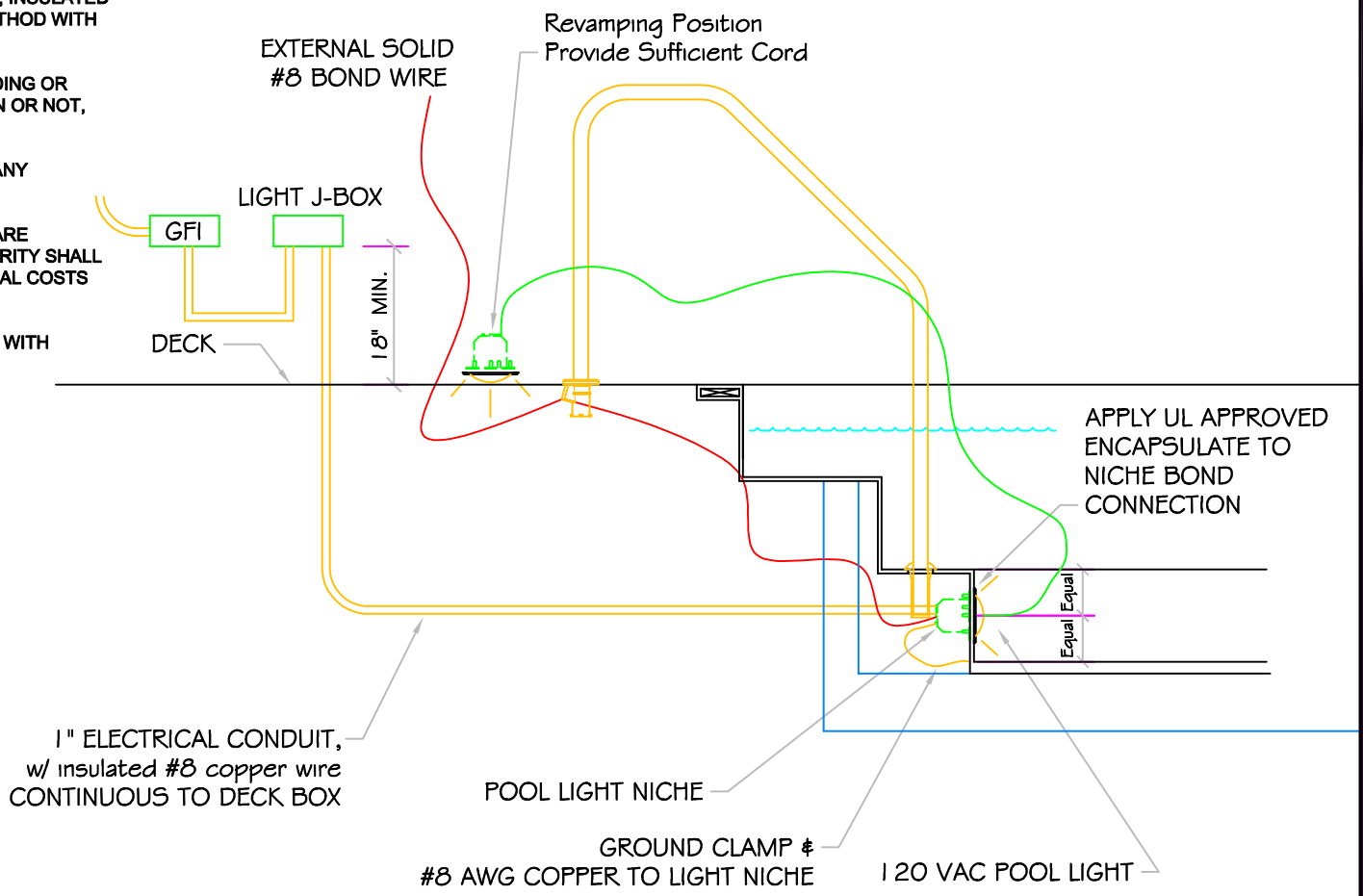

\*ALL DIMENSIONS SUBJECT TO 1/4" TOLERANCES\*

These drawings, concepts, and details contained herein are the original proprietary designs of NESPA ENTERPRISES, developed over many years of experience in the pool and spa industry and as such are protected by the copyright laws of the United States Government. Reproduction of any of the above without written permission to do so by NESPA ENTERPRISES, is illegal.

**NESPA ENTERPRISES INC.**  
 2800 Richter Ave. Ste. C Oroville, CA 95966  
 Office: (530) 534-9910 Fax: (530) 534-9915  
 E-Mail: [sales@tiledspas.com](mailto:sales@tiledspas.com) Web Site: [www.tiledspas.com](http://www.tiledspas.com)



SIZE A	DWG NAME DETAILS	DWG TYPE Detail
SCALE 1/2" = 1'	DATE 7/24/2008	SHEET PAGE 1 OF 1

## **NESPA ENTERPRISES, Inc. LIMITED WARRANTY**

**This LIMITED WARRANTY covering NESPA products is extended to the ORIGINAL PURCHASER-USER BY NESPA ENTERPRISES Inc.(NESPA), 2800 Richter Ave. Unit C California 95966.**

**NESPA products are thoroughly inspected and tested prior to factory shipment. NESPA warrants to the ORIGINAL PURCHASER-USER that NESPA Spas and Swim Spas will be free of defect in workmanship, accessories and parts, provided said accessories and parts were manufactured by NESPA. NESPA, under this LIMITED WARRANTY, warrants only that its Spas and Swim Spas shall be structurally sound, shall retain their shape, and shall retain water for the warranty period. NESPA warrants the adhesion of tile to fiberglass for a period of three (3) years and structural soundness for ten (10) years. NESPA warrants epoxy grout adhesion for a period of three years. If any such defects appear and are reported within the warranty period, NESPA shall repair or replace such defective parts without charge if an inspection proves the claim.**

**The provisions of the LIMITED WARRANTY shall not apply to tile cracked, split, chipped or damaged after the product has left the factory, nor damage to tile caused by freezing nor to damage, defect, malfunction or failure to conform with the above warranty provisions where the damage, defect, malfunction or failure to conform was caused during shipment or by distributor or by unreasonable use by ORIGINAL PURCHASER-USER including improper water balance and improper sand pack or support.**

**This LIMITED WARRANTY shall not apply to any plumbing, equipment, or installation of spas and Swim Spas and shall not apply to any alterations made to or upon NESPA products except alterations made by NESPA employees or NESPA authorized representatives.**

**This LIMITED WARRANTY is expressly in lieu of all other warranties expressed or implied including the warranties of merchantability and fitness for use and all other obligations or liabilities on NESPA'S part, and NESPA neither assumes nor authorizes any other person to assume for NESPA any other liability in connection with the sale of this NESPA product. This LIMITED WARRANTY shall not apply to this NESPA product or any part thereof which has been subject to accident, negligence, alteration, abuse or misuse. NESPA makes no warranty whatsoever with respect to accessories or parts not manufactured by NESPA.**

**The term "ORIGINAL PURCHASER-USER" as used in this LIMITED WARRANTY shall be deemed to mean that person for whom the NESPA product is originally installed.**

**The LIMITED WARRANTY provided herein and the obligations and liabilities of NESPA hereunder are exclusive and are in lieu of, and buyer and original PURCHASE-USER hereby waive all other remedies, warranties, guarantees or liabilities, expressed or implied, arising by law or otherwise (including without limitation and obligations of NESPA with respect to fitness, merchantability, and consequential damages) or whether or not occasioned by NESPA'S negligence.**

**This LIMITED WARRANTY shall not be extended, altered or varied except by a written instrument signed by NESPA and original PURCHASER-USER.**